

# MAINTENANCE REMINDER SHEET

## X584 with 54" Accel Deep™ Deck

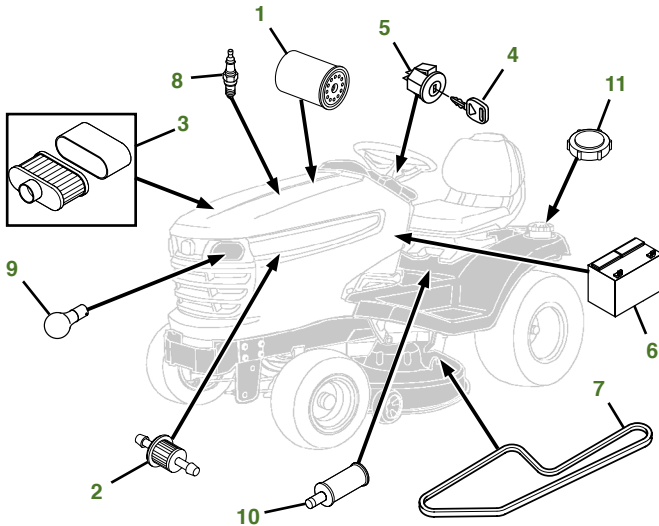

Tractor S/N

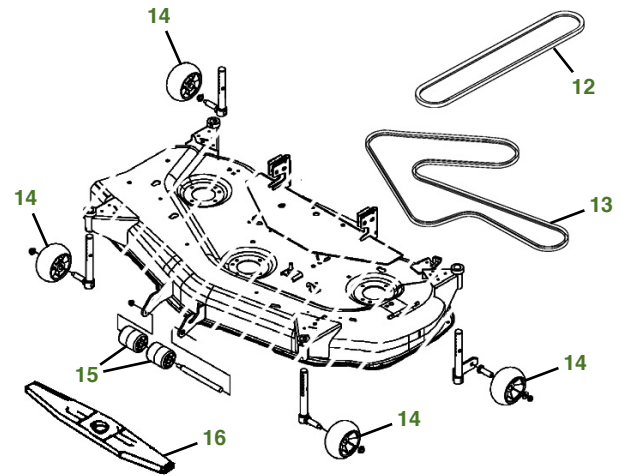

Deck S/N

Key	Part No.	Description	Key	Part No.	Description
1	<a href="#">AM125424</a>	ENGINE OIL FILTER	7	<a href="#">M174585</a>	BELT-TRAC DRIVE
2	<a href="#">AM116304</a>	FUEL FILTER-IN-LINE	8	<a href="#">M805853</a>	SPARK PLUG
3	<a href="#">MIU12554</a>	AIR FILTER-FOAM	9	<a href="#">AD2062R</a>	HEADLIGHT BULB
	<a href="#">MIU12555</a>	AIR FILTER-PAPER	10	<a href="#">MIA881446</a>	TRANSAXLE FILTER
4	<a href="#">GY20680</a>	KEY	11	<a href="#">AM141406</a>	FUEL CAP
5	<a href="#">AM133597</a>	IGNITION SWITCH	12	<a href="#">M169485</a>	BELT-MOWER-PRIMARY
6	<a href="#">TY25876</a>	BATTERY	13	<a href="#">M169486</a>	BELT-MOWER-SECONDARY
			14	<a href="#">M111489</a>	GAGE WHEEL
			15	<a href="#">M113955</a>	FRONT ROLLER
			16	<a href="#">M143520</a>	BLADE-SIDE DISCHARGE 54"
				<a href="#">M177791</a>	BLADE-MULCHING 54"
				<a href="#">BM24994</a>	MulchControl™ KIT

### Parts Needed in First 250 Hours of Operation

Qty	Part No	Item	Qty or Capacity	Change Interval In Hours
7	<a href="#">TY22029</a>	1 qt Engine Oil Turf-Gard™ 10W30	2.2 qt	8/100/200
3	<a href="#">AM125424</a>	Engine Oil Filter	1	8/100/200
2	<a href="#">MIA881446</a>	Transaxle Filter	1	50/200
12	<a href="#">TY22035</a>	1 qt Low Viscosity Hy-Gard™	5.6 qt	50/200
2	<a href="#">MIU12554</a>	Air Filter-Foam	1	100/200
2	<a href="#">MIU12555</a>	Air Filter-Paper	1	100/200
2	<a href="#">AM116304</a>	Fuel Filter-In-Line	1	100/200
4	<a href="#">M805853</a>	Spark Plug	2	100/200
2	<a href="#">TY24416</a>	John Deere Multi-Purpose HD Lithium Complex Grease		As Needed

### "As Needed" Parts

Qty	Part No	Item
1	<a href="#">AM130907</a>	Mower Deck Leveling Gauge
1	<a href="#">TY26518</a>	Grease Gun

### Home Maintenance Kit

Unit	Kit Number
X584	<a href="#">LG265</a>

CLICK PART NUMBER TO BUY