

MAINTENANCE REMINDER SHEET

X570 with 54" Accel Deep™ Deck

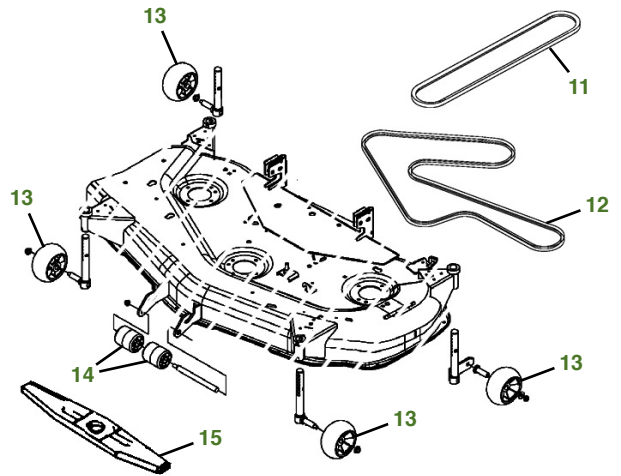
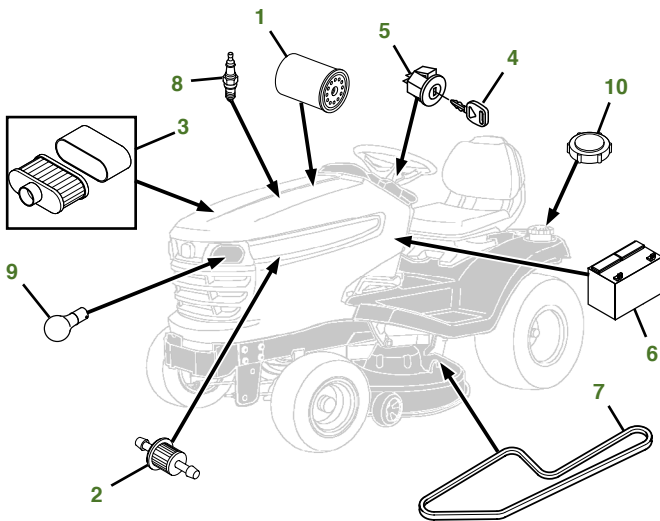

Tractor S/N

Deck S/N

Key	Part No.	Description	Key	Part No.	Description
1	AM125424	ENGINE OIL FILTER	7	M174585	BELT-TRAC DRIVE
2	AM116304	FUEL FILTER-IN-LINE	8	M805853	SPARK PLUG
3	MIU12554	AIR FILTER-FOAM	9	AD2062R	HEADLIGHT BULB
	MIU12555	AIR FILTER-PAPER	10	AM141406	FUEL CAP
4	GY20680	KEY	11	M169485	BELT-MOWER-PRIMARY
5	AM133597	IGNITION SWITCH	12	M169486	BELT-MOWER-SECONDARY
6	TY25876	BATTERY	13	M111489	GAGE WHEEL
			14	M113955	FRONT ROLLER
			15	M143520	BLADE-SIDE DISCHARGE 54"
				M177791	BLADE-MULCHING 54"
				BM24994	MulchControl™ KIT

Parts Needed in First 250 Hours of Operation

Qty	Part No	Item	Qty or Capacity	Change Interval In Hours
7	TY22029	1 qt Engine Oil Turf-Gard™ 10W30	2.2 qt	8/100/200
3	AM125424	Engine Oil Filter	1	8/100/200
2	MIU12554	Air Filter-Foam	1	100/200
2	MIU12555	Air Filter-Paper	1	100/200
2	AM116304	Fuel Filter-In-Line	1	100/200
4	M805853	Spark Plug	2	100/200
2	TY24416	John Deere Multi-Purpose HD Lithium Complex Grease		As Needed

"As Needed" Parts

Qty	Part No	Item
1	AM130907	Mower Deck Leveling Gauge
1	TY26518	Grease Gun

Home Maintenance Kit

Unit	Kit Number
X570	LG265

CLICK PART NUMBER TO BUY