

MAINTENANCE REMINDER SHEET

X340 with 42" Edge Deck

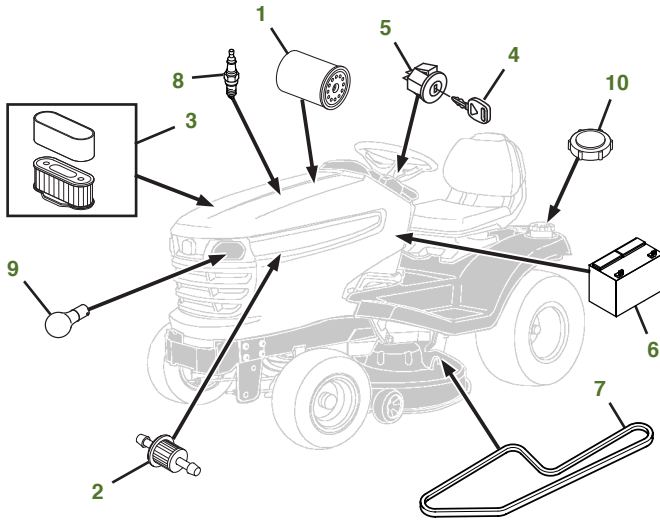

Tractor S/N

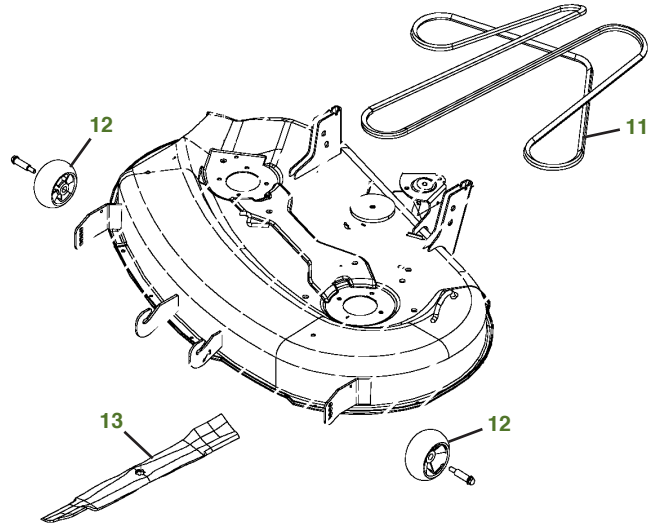

Deck S/N

Key	Part No.	Description	Key	Part No.	Description
1	AM107423	ENGINE OIL FILTER	8	M805853	SPARK PLUG
2	AM116304	FUEL FILTER-IN-LINE	9	AD2062R	HEADLIGHT BULB
3	M140295	AIR FILTER-FOAM	10	AM137724	FUEL CAP
	M150949	AIR FILTER-PAPER	11	M154621	BELT-MOWER
4	GY20680	KEY	12	M111489	GAGE WHEEL
5	AM133596	IGNITION SWITCH (S/N -044999)	13	AM141032	KIT-SIDE DISCHARGE 42"
	AM133597	IGNITION SWITCH (S/N 045000-)		AM141034	KIT-BAGGING 42"
6	TY25878	BATTERY		AM141033	KIT-MULCHING 42"
7	M151277	BELT-TRAC DRIVE (S/N -044999)			
	M144044	BELT-TRAC DRIVE (S/N 045000-)			

Parts Needed in First 250 Hours of Operation

Qty	Part No	Item	Qty or Capacity	Change Interval In Hours
7	TY22029	1 qt Engine Oil Turf-Gard™ 10W30	2.1 qt	8/100/200
3	AM107423	Engine Oil Filter	1	8/100/200
2	M140295	Air Filter-Foam	1	100/200
2	M150949	Air Filter-Paper	1	100/200
2	AM116304	Fuel Filter-In-Line	1	100/200
4	M805853	Spark Plug	2	100/200
2	TY6341	JD Multi Purpose SD Polyurea Grease		As Needed

"As Needed" Parts

Qty	Part No	Item
1	AM130907	Mower Deck Leveling Gauge
1	TY26518	Grease Gun

Home Maintenance Kit

Unit	Kit Number
X340	LG249

CLICK PART NUMBER TO BUY