

JOHN DEERE GUIDE 5, EDGE TRIM, WINDOWS AND DOOR SEALS

CONTENTS

TYPE

PAGE

ACCORDIAN SEALS

Page.10



BULB SEALS

Page. 1, 2, 3



EXTRUSIONS SEALS

Page.4, 5



FLAP SEALS

Page. 6, 7



PVC EDGE TRIM

Page. 11, 12



SILICONE SEALS

Page. 13

TAPE SEALS

Page. 8, 9



WINDOW & PANEL SEALS

Page. 14



JOHN DEERE GUIDE 5, EDGE TRIM, WINDOW AND DOOR SEALS

BULB SEALS

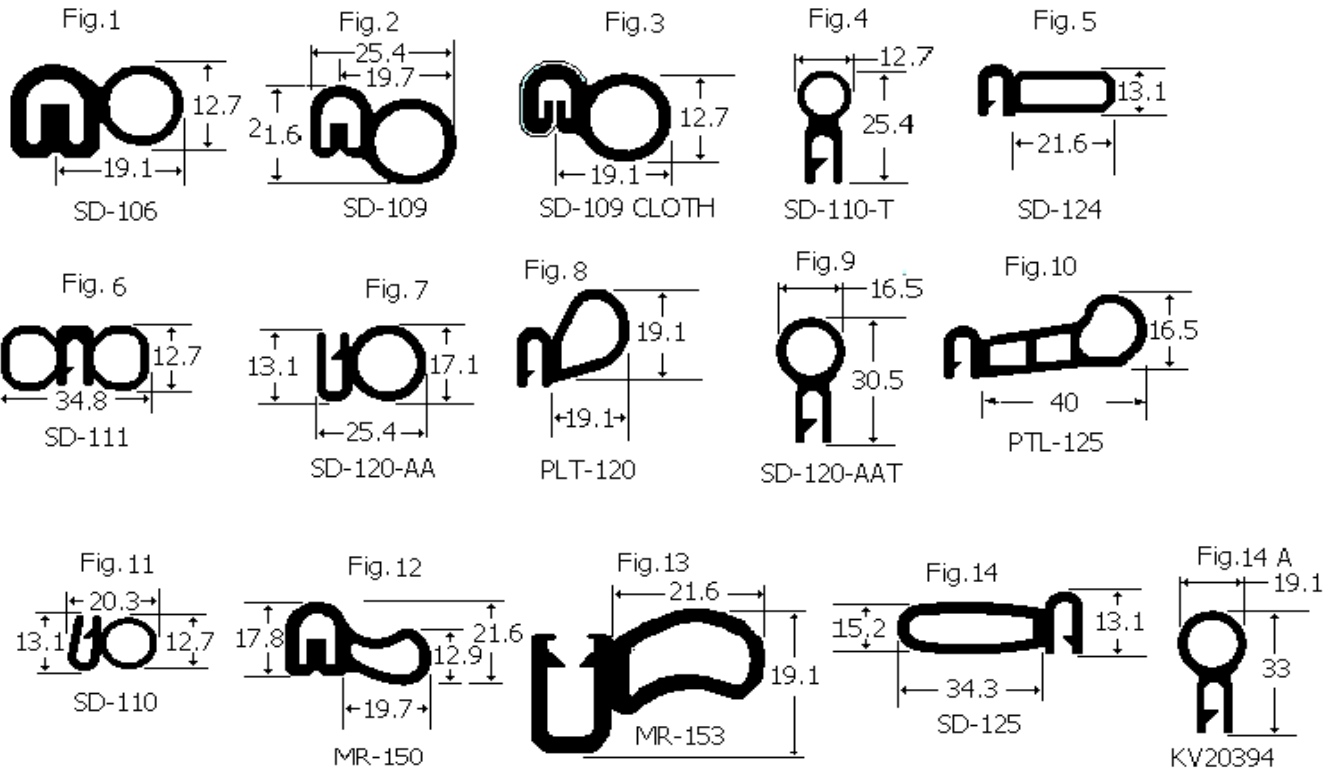

FIG.	PART NUMBER	I.D. NUMBER	GRIP/SIZE mm	REINFORCEMENT	MATERIAL	LENGTH	BULK
1	UNI-GRIP	SD-106	3.1 - 4.8	FLEXABLE STEEL CORE	EPDM SPUNGE RUB.		Non Preferred
2	AH83276	UNI-GRIP	SD-109	FLEXABLE STEEL CORE	EPDM SPUNGE RUB.		Non Preferred
2	T58341	UNI-GRIP	SD-109	FLEXABLE STEEL CORE	EPDM SPUNGE RUB.	15240	S
3	UNI-GRIP	SD-109-CLOTH	3.1 - 4.8	FLEXABLE STEEL CORE	EPDM SPUNGE RUB.		Non Preferred
4	UNI-GRIP	SD-110-T	3.1 - 4.8	FLEXABLE STEEL CORE	EPDM SPUNGE RUB.		Non Preferred
5	UNI-GRIP	SD-124	3.1 - 4.8	FLEXABLE STEEL CORE	EPDM SPUNGE RUB.		Non Preferred
6	UNI-GRIP	SD-111	3.1 - 4.8	FLEXABLE STEEL CORE	EPDM SPUNGE RUB.		Non Preferred
7	UNI-GRIP	SD-120-AA	3.1 - 4.8	FLEXABLE STEEL CORE	EPDM SPUNGE RUB.		Non Preferred
8	UNI-GRIP	PLT-120	3.1 - 4.8	FLEXABLE STEEL CORE	EPDM SPUNGE RUB.		Non Preferred
9	UNI-GRIP	SD-120-AAA	3.1 - 4.8	FLEXABLE STEEL CORE	EPDM SPUNGE RUB.		Non Preferred
10	UNI-GRIP	PLT-125	3.1 - 4.8	FLEXABLE STEEL CORE	EPDM SPUNGE RUB.		Non Preferred
11	M140855	UNI-GRIP	SD-110-T	FLEXABLE STEEL CORE	EPDM SPUNGE RUB.		
12	UNI-GRIP	MR-150	6.3	FLEXABLE STEEL CORE	EPDM SPUNGE RUB.		Non Preferred
13	UNI-GRIP	MR-153	3.1 - 4.8	FLEXABLE STEEL CORE	EPDM SPUNGE RUB.		Non Preferred
14	UNI-GRIP	SD125	3.1 - 4.8	FLEXABLE STEEL CORE	EPDM SPUNGE RUB.		Non Preferred

For new part numbers contact Deere & Co Engineering Standards: (309) 765-4918 or (309) 765-4712

BULB SEALS

FIG. PART NUMBER

I.D. NUMBER GRIP/SIZE mm REINFORCEMENT MATERIAL LENGTH BULK

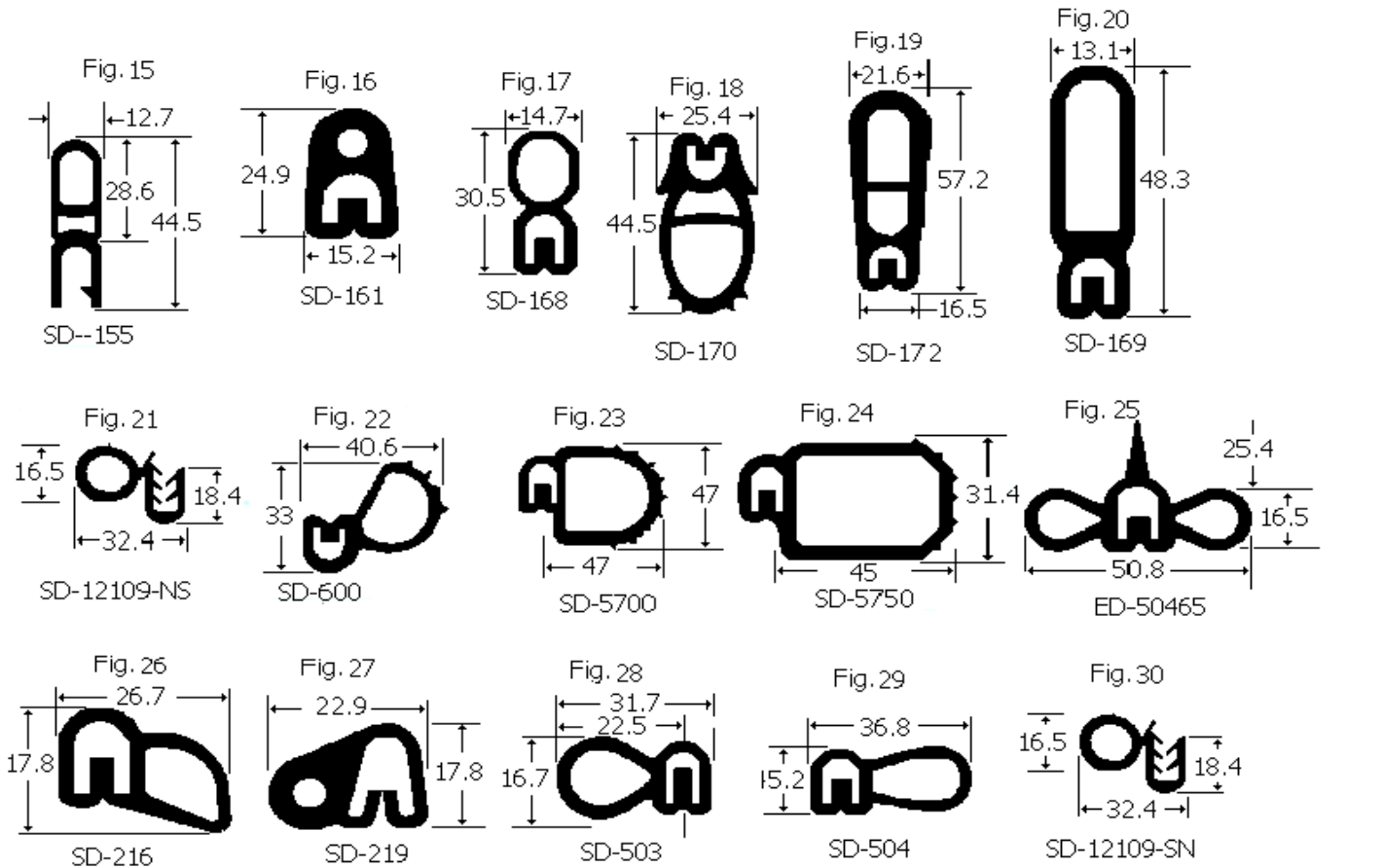
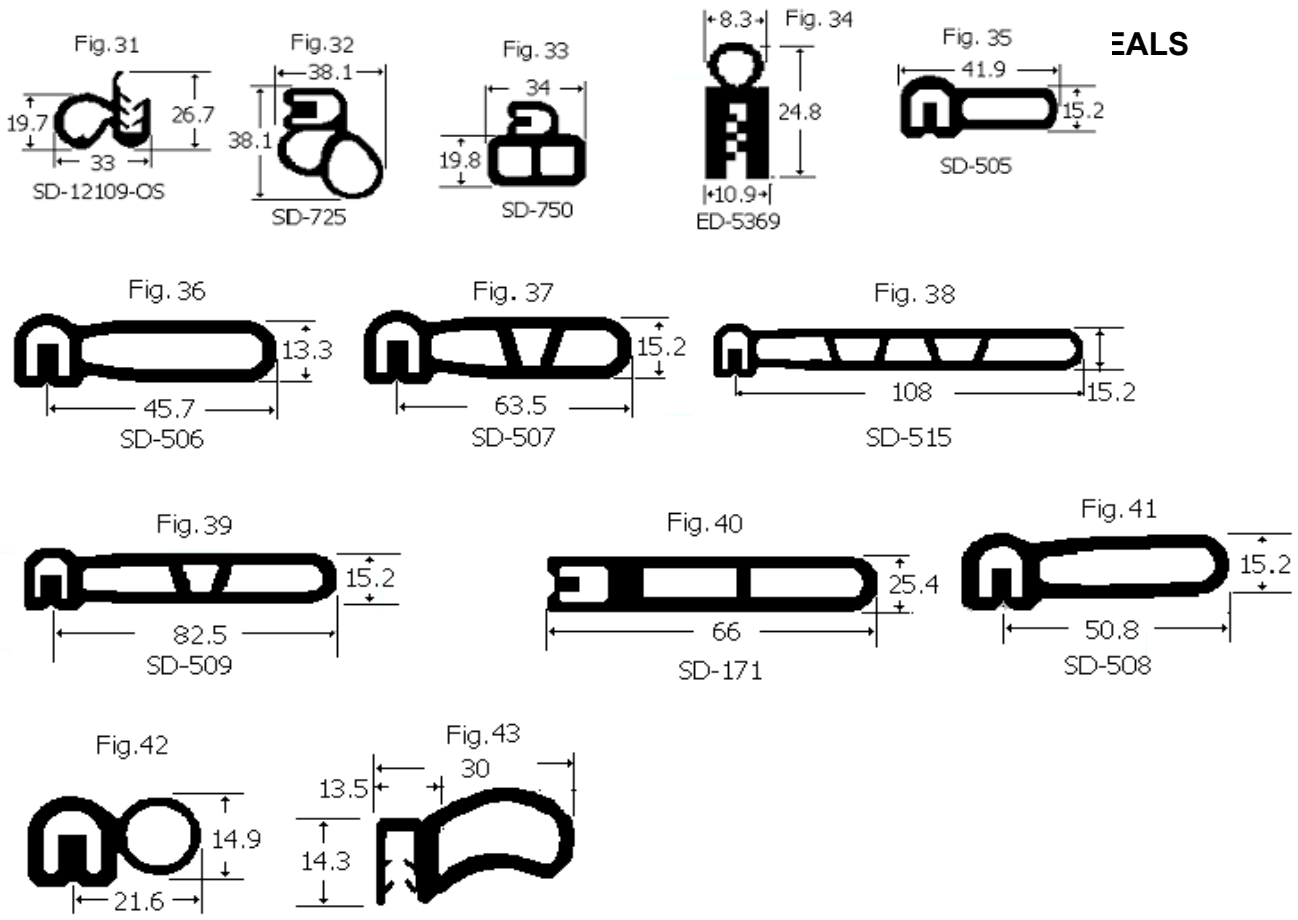

Fig.	Part Number	I.D. Number	GRIP/SIZE mm	REINFORCEMENT	MATERIAL	LENGTH	BULK
15		UNI-GRIP SD-155	3.1-4.8	FLEXABLE STEEL CORE	EPDM SPUNGE RUB.		Non Preferred
16	AH160298	UNI-GRIP SD-161	3.1-4.8	FLEXABLE STEEL CORE	EPDM SPUNGE RUB.	ASSY	
16	AH168669	UNI-GRIP SD-161	3.1-4.8	FLEXABLE STEEL CORE	EPDM SPUNGE RUB.	ASSY	
16	AH168675	UNI-GRIP SD-161	3.1-4.8	FLEXABLE STEEL CORE	EPDM SPUNGE RUB.	ASSY	
16	AH170252	UNI-GRIP SD-161	3.1-4.8	FLEXABLE STEEL CORE	EPDM SPUNGE RUB.	ASSY	
16	N221372	UNI-GRIP SD-161	3.1-4.8	FLEXABLE STEEL CORE	EPDM SPUNGE RUB.	311.1	
17	AH133705	UNI-GRIP SD-168	3.1-4.8	FLEXABLE STEEL CORE	EPDM SPUNGE RUB.		N/S BULK
17	AH140967	UNI-GRIP SD-168	3.1-4.8	FLEXABLE STEEL CORE	EPDM SPUNGE RUB.	ASSY	
17	AM129203	UNI-GRIP SD-168	3.1-4.8	FLEXABLE STEEL CORE	EPDM SPUNGE RUB.	2616	
17	AR67041	UNI-GRIP SD-168	3.1-4.8	FLEXABLE STEEL CORE	EPDM SPUNGE RUB.	188	
17	E80976	UNI-GRIP SD-168	3.1-4.8	FLEXABLE STEEL CORE	EPDM SPUNGE RUB.	200	
17	H131108	UNI-GRIP SD-168	3.1-4.8	FLEXABLE STEEL CORE	EPDM SPUNGE RUB.	138	
17	T63949	UNI-GRIP SD-168	3.1-4.8	FLEXABLE STEEL CORE	EPDM SPUNGE RUB.	7620	S
17	DT5004	UNI-GRIP SD-168	3.1-4.8	FLEXABLE STEEL CORE	EPDM SPUNGE RUB.	NONE	
18		UNI-GRIP SD-170	3.1-4.8	FLEXABLE STEEL CORE	EPDM SPUNGE RUB.		Non Preferred
19		UNI-GRIP SD172	3.1-4.8	FLEXABLE STEEL CORE	EPDM SPUNGE RUB.		Non Preferred
20		UNI-GRIP SD169	3.1-4.8	FLEXABLE STEEL CORE	EPDM SPUNGE RUB.		Non Preferred
21		UNI-GRIP SD-12109-NS	3.1-4.8	FLEXABLE STEEL CORE	EPDM SPUNGE RUB.		Non Preferred
22		UNI-GRIP SD-600	3.1-4.8	FLEXABLE STEEL CORE	EPDM SPUNGE RUB.		Non Preferred
23		UNI-GRIP SD-5700	3.1-4.8	FLEXABLE STEEL CORE	EPDM SPUNGE RUB.		Non Preferred
24		UNI-GRIP SD-5750	3.1-4.8	FLEXABLE STEEL CORE	EPDM SPUNGE RUB.		Non Preferred
25		UNI-GRIP ED-50465	3.1-4.8	FLEXABLE STEEL CORE	EPDM SPUNGE RUB.		Non Preferred
26		UNI-GRIP SD-216	3.1-4.8	FLEXABLE STEEL CORE	EPDM SPUNGE RUB.		Non Preferred
27		UNI-GRIP SD-219	3.1-4.8	FLEXABLE STEEL CORE	EPDM SPUNGE RUB.		Non Preferred
28	AH80335	UNI-GRIP SD-503	3.1-4.8	FLEXABLE STEEL CORE	EPDM SPUNGE RUB.	15240	S
28	AH83825	UNI-GRIP SD-503	3.1-4.8	FLEXABLE STEEL CORE	EPDM SPUNGE RUB.	ASSY	
28	AH130137	UNI-GRIP SD-503	3.1-4.8	FLEXABLE STEEL CORE	EPDM SPUNGE RUB.	4350	
28	AE41176	UNI-GRIP SD-503	3.1-4.8	FLEXABLE STEEL CORE	EPDM SPUNGE RUB.	3750	
28	E81651	UNI-GRIP SD-503	3.1-4.8	FLEXABLE STEEL CORE	EPDM SPUNGE RUB.	120	
28	E86325	UNI-GRIP SD-503	3.1-4.8	FLEXABLE STEEL CORE	EPDM SPUNGE RUB.	4030	
28	T132817	UNI-GRIP SD-503	3.1-4.8	FLEXABLE STEEL CORE	EPDM SPUNGE RUB.	4280	
29		UNI-GRIP SD-504	3.1-4.8	FLEXABLE STEEL CORE	EPDM SPUNGE RUB.		Non Preferred
30		UNI-GRIP SD-12109-SN	3.1-4.8	FLEXABLE STEEL CORE	EPDM SPUNGE RUB.		Non Preferred

BULB SEALS



SEALS

FIG.	PART NUMBER	I.D. NUMBER	GRIP/SIZE mm	REINFORCEMENT	MATERIAL	LENGTH
31	UN5503	UNI-GRIP SD-12109-OS	3.1-4.8	FLEXABLE STEEL CORE	EPDM SPUNGE RUB.	NONE
32		UNI-GRIP SD725	6.3	FLEXABLE STEEL CORE	EPDM SPUNGE RUB.	Non Preferred
33		UNI-GRIP SD750	6.5	FLEXABLE STEEL CORE	EPDM SPUNGE RUB.	Non Preferred
34	H151068	UNI-GRIP ED-5369	3.1-4.8	FLEXABLE STEEL CORE	EPDM SPUNGE RUB.	145
34	H167220	UNI-GRIP ED-5369	3.1-4.8	FLEXABLE STEEL CORE	EPDM SPUNGE RUB.	120
35		UNI-GRIP SD-505	3.1-4.8	FLEXABLE STEEL CORE	EPDM SPUNGE RUB.	Non Preferred
36	AH125163	UNI-GRIP SD-506	3.1-4.8	FLEXABLE STEEL CORE	EPDM SPUNGE RUB. O SERVICE	Non Preferred
37		UNI-GRIP SD-507	3.1-4.8	FLEXABLE STEEL CORE	EPDM SPUNGE RUB.	Non Preferred
38		UNI-GRIP SD-515	3.1-4.8	FLEXABLE STEEL CORE	EPDM SPUNGE RUB.	Non Preferred
39		UNI-GRIP SD-509	3.1-4.8	FLEXABLE STEEL CORE	EPDM SPUNGE RUB.	Non Preferred
40		UNI-GRIP SD-171	3.1-4.8	FLEXABLE STEEL CORE	EPDM SPUNGE RUB.	Non Preferred
41		UNI-GRIP SD-508	3.1-4.8	FLEXABLE STEEL CORE	EPDM SPUNGE RUB.	Non Preferred

For new part numbers contact Deere & Co Engineering Standards: (309) 765-4918 or (309) 765-4712

JOHN DEERE GUIDE 5, EDGE TRIM, WINDOW AND DOOR SEALS

RUBBER EXTRUSIONS

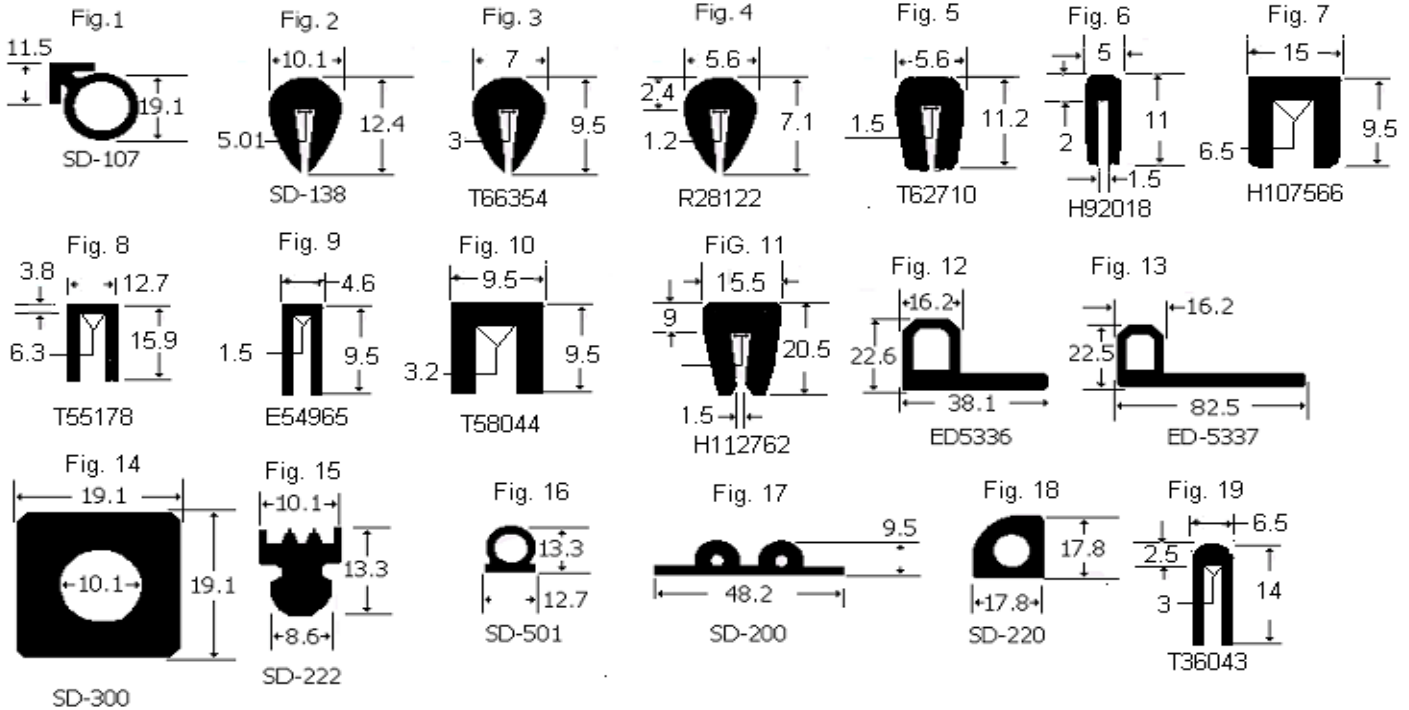

FIG.	PART NUMBER	UNI-GRIP	I.D. NUMBER	GRIP/SIZE mm	REINFORCEMENT	MATERIAL	LENGTH
1		UNI-GRIP	SD-107			EPDM SPUNGE RUB.	Non Preferred
2		UNI-GRIP	SD-138			EPDM SPUNGE RUB.	Non Preferred
3	T66354	UNI-GRIP	T66354			EPDM SPUNGE RUB.	15240 S
4	R33846	UNI-GRIP	R33849			EPDM SPUNGE RUB.	1727
4	R28122	UNI-GRIP	R28122			EPDM SPUNGE RUB.	1835
5	T62710	UNI-GRIP	T62710			EPDM SPUNGE RUB.	5486 NO/INV
5	M43640	UNI-GRIP	M43640			VNYL	30
5	M44292	UNI-GRIP	M44292			VNYL	845
5	M43979	UNI-GRIP	M43979			VNYL	889
5	M44391	UNI-GRIP	M44391			VNYL	3048
6	H92018	UNI-GRIP	H92018			EPDM SPUNGE RUB.	3048
7	H107566	UNI-GRIP	H107566			EPDM	24
8	T55178	UNI-GRIP	T55178			EPDM SPUNGE RUB.	1070
9	E54965	UNI-GRIP	E54965			EPDM SPUNGE RUB.	1717
10	T58044	UNI-GRIP	T58044			EPDM SPUNGE RUB.	254
11	H112762	UNI-GRIP	H112762			EPDM SPUNGE RUB.	90
12		UNI-GRIP	ED-5336			EPDM SPUNGE RUB.	Non Preferred
13		UNI-GRIP	ED-5337			EPDM SPUNGE RUB.	Non Preferred
14		UNI-GRIP	SD0300			EPDM SPUNGE RUB.	Non Preferred
15		UNI-GRIP	SD-222			EPDM SPUNGE RUB.	Non Preferred
16		UNI-GRIP	SD-501			EPDM SPUNGE RUB.	Non Preferred
17		UNI-GRIP	SD-200			EPDM SPUNGE RUB.	Non Preferred
18		UNI-GRIP	SD-220			EPDM SPUNGE RUB.	Non Preferred
19	T36043	UNI-GRIP	T36043			EPDM	1422

For new part numbers contact Deere & Co Engineering Standards: (309) 765-4918 or (309) 765-4712

2001-09-25

JOHN DEERE GUIDE 5, EDGE TRIM, WINDOW AND DOOR SEALS

RUBBER EXTRUSIONS

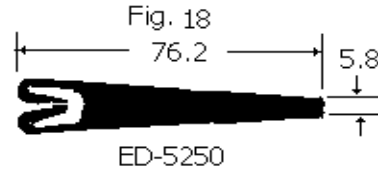
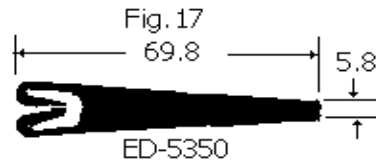
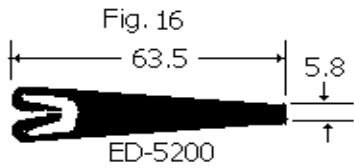
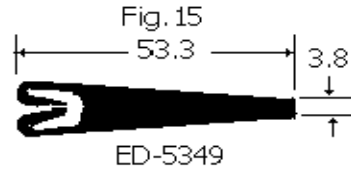
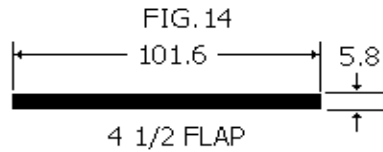
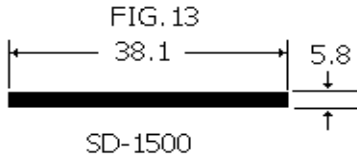
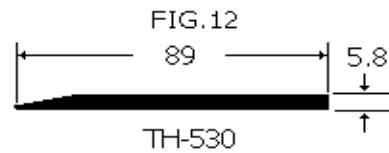
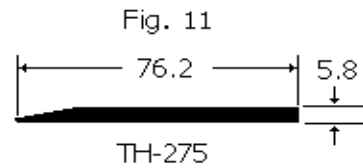
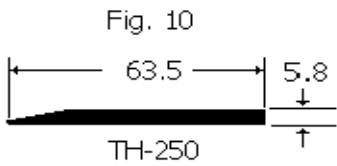

FIG. PART NUMBER	I.D. NUMBER	GRIP/SIZE mm	REINFORCEMENT	MATERIAL	LENGTH
10	UNI-GRIP TH-250	NONE	NONE	EPDM SPUNGE RUB.	Non Preferred
11	UNI-GRIP TH-275	NONE	NONE	EPDM SPUNGE RUB.	Non Preferred
12	UNI-GRIP TH-530	NONE	NONE	EPDM SPUNGE RUB.	Non Preferred
13	UNI-GRIP SD-1500	NONE	NONE	EPDM SPUNGE RUB.	Non Preferred
14	UNI-GRIP 4 1/2 FLAP	NONE	NONE	EPDM SPUNGE RUB.	Non Preferred
15	UNI-GRIP ED-5349	3.1-4.8	FLEXABLE STEEL CORE	EPDM SPUNGE RUB.	Non Preferred
16	UNI-GRIP ED-5200	3.1-4.8	FLEXABLE STEEL CORE	EPDM SPUNGE RUB.	Non Preferred
17	UNI-GRIP ED-5350	3.1-4.8	FLEXABLE STEEL CORE	EPDM SPUNGE RUB.	Non Preferred
18	UNI-GRIP ED-5250	3.1-4.8	FLEXABLE STEEL CORE	EPDM SPUNGE RUB.	Non Preferred

For new part numbers contact Deere & Co Engineering Standards: (309) 765-4918 or (309) 765-4712

2001-09-25

JOHN DEERE GUIDE 5, EDGE TRIM, WINDOW AND DOOR SEALS

FLAP SEALS

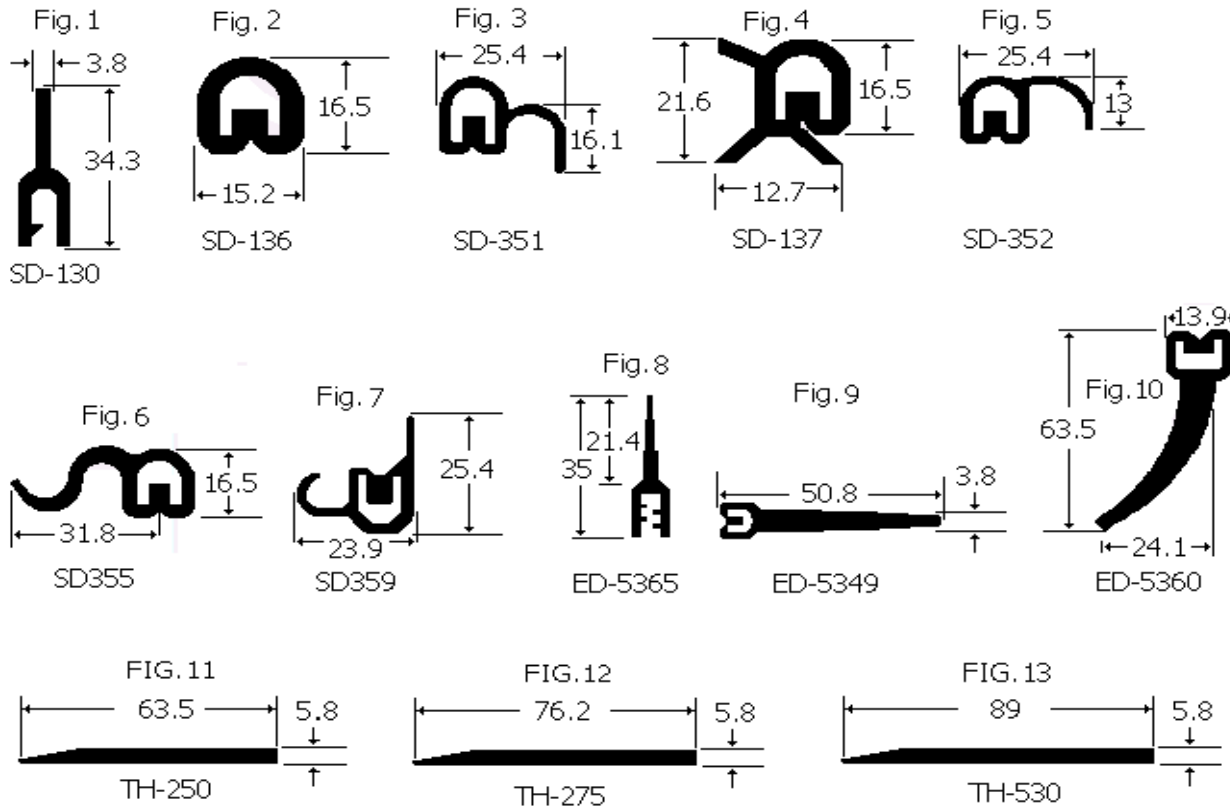

FIG.	PART NUMBER	I.D. NUMBER	GRIP/SIZE mm	REINFORCEMENT	MATERIAL	LENGTH
1	UNI-GRIP	SD-130	3.1-4.8	FLEXABLE STEEL CORE	EPDM SPUNGE RUB.	Non Preferred
2	UNI-GRIP	SD-136	3.1-4.8	FLEXABLE STEEL CORE	EPDM SPUNGE RUB.	Non Preferred
3	UNI-GRIP	SD-351	3.1-4.8	FLEXABLE STEEL CORE	EPDM SPUNGE RUB.	Non Preferred
4	UNI-GRIP	SD-137	3.1-4.8	FLEXABLE STEEL CORE	EPDM SPUNGE RUB.	Non Preferred
5	DT5133	UNI-GRIP	SD-352	3.1-4.8	FLEXABLE STEEL CORE	EPDM SPUNGE RUB. NONE
6	UNI-GRIP	SD-355	3.1-4.8	FLEXABLE STEEL CORE	EPDM SPUNGE RUB.	Non Preferred
7	UNI-GRIP	SD-359	3.1-4.8	FLEXABLE STEEL CORE	EPDM SPUNGE RUB.	Non Preferred
8	UNI-GRIP	ED-5365	3.1-4.8	FLEXABLE STEEL CORE	EPDM SPUNGE RUB.	Non Preferred
9	UNI-GRIP	ED-5349	3.1-4.8	FLEXABLE STEEL CORE	EPDM SPUNGE RUB.	Non Preferred
10	UNI-GRIP	ED-5360	3.1-4.8	FLEXABLE STEEL CORE	EPDM SPUNGE RUB.	Non Preferred
11	UNI-GRIP	TH-250	3.1-4.8	FLEXABLE STEEL CORE	EPDM SPUNGE RUB.	Non Preferred
12	UNI-GRIP	TH275	3.1-4.8	FLEXABLE STEEL CORE	EPDM SPUNGE RUB.	Non Preferred
13	UNI-GRIP	TH530	3.1-4.8	FLEXABLE STEEL CORE	EPDM SPUNGE RUB.	Non Preferred

For new part numbers contact Deere & Co Engineering Standards: (309) 765-4918 or (309) 765-4712

JOHN DEERE GUIDE 5, EDGE TRIM, WINDOW AND DOOR SEALS

FLAP SEALS

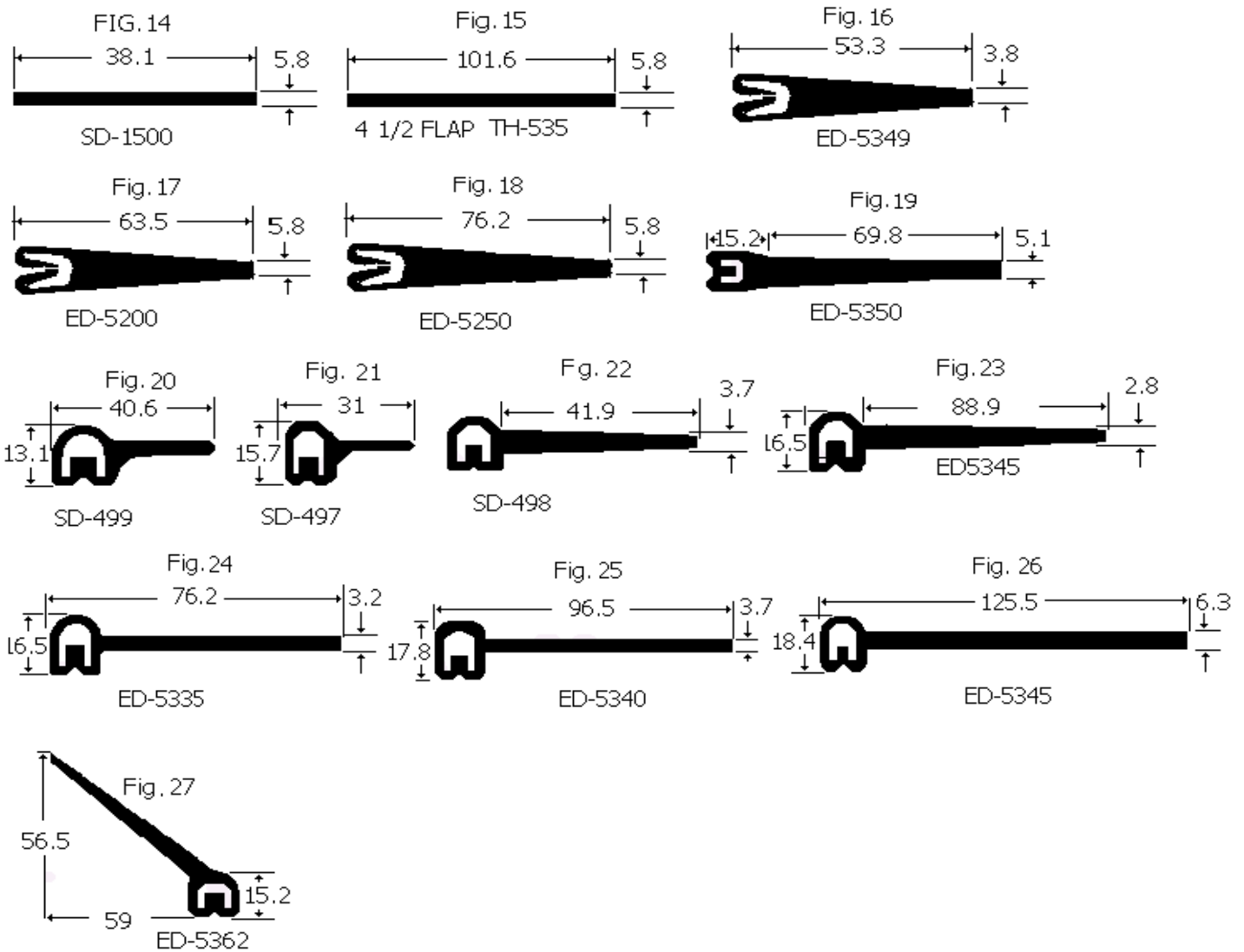

FIG. PART NUMBER	I.D. NUMBER	GRIP/SIZE mm	REINFORCEMENT	MATERIAL	LENGTH	BULK
14	UNI-GRIP	NONE	NONE			Non Preferred
15	UNI-GRIP	NONE	NONE			Non Preferred
16	UNI-GRIP	3.1-4.8	FLEXABLE STEEL CORE			Non Preferred
17	UNI-GRIP	3.1-4.8	FLEXABLE STEEL CORE			Non Preferred
18	UNI-GRIP	3.1-4.8	FLEXABLE STEEL CORE			Non Preferred
19	UNI-GRIP	3.1-4.8	FLEXABLE STEEL CORE			Non Preferred
20	UNI-GRIP	3.1-4.8	FLEXABLE STEEL CORE			Non Preferred
21	T41341	UNI-GRIP	SD-497	3.1-4.8	FLEXABLE STEEL CORE	610
21	T41342	UNI-GRIP	SD-497	3.1-4.8	FLEXABLE STEEL CORE	937.3
21	AH160269			3.1-4.8	FLEXABLE STEEL CORE	ASSY
22	UNI-GRIP	3.1-4.8	FLEXABLE STEEL CORE			Non Preferred
23	UNI-GRIP	3.1-4.8	FLEXABLE STEEL CORE			Non Preferred
24	UNI-GRIP	3.1-4.8	FLEXABLE STEEL CORE			
25	AH139393	UNI-GRIP	ED-5345	3.1-4.8	FLEXABLE STEEL CORE C/S NEOPRENE	1250
26	AH141774	UNI-GRIP	ED-5345	3.1-4.8	FLEXABLE STEEL CORE C/S NEOPRENE	1560
27	UNI-GRIP	3.1-4.8	FLEXABLE STEEL CORE			Non Preferred

For new part numbers contact Deere & Co Engineering Standards: (309) 765-4918 or (309) 765-4712

JOHN DEER GUIDE 5, EDGE TRIM, WINDOW AND DOOR SEALS

TAPE SEALS

FIG.	PART NUMBER	I.D. NUMBER	GRIP/TAPE	REINFORCEMENT	MATERIAL	LENGTH
1	UNI-GRIP	DO-01-T	TAPE	NONE	EPDM SPUNGE RUB.	Non Preferred
2	UNI-GRIP	SD-112-T	TAPE	NONE	EPDM SPUNGE RUB.	Non Preferred
3	UNI-GRIP	SD-113-T	TAPE	NONE	EPDM SPUNGE RUB.	Non Preferred
4	AH160405	UNI-GRIP	SD-116-T	TAPE	NONE	EPDM SPUNGE RUB. 1580 S
5	UNI-GRIP	SD-117-T	TAPE	NONE	EPDM SPUNGE RUB.	Non Preferred
6	UNI-GRIP	PC-125-T	TAPE	NONE	EPDM SPUNGE RUB.	Non Preferred
7	UNI-GRIP	GF-145-T	TAPE	NONE	EPDM SPUNGE RUB.	Non Preferred
8	UNI-GRIP	SD-190-WT	TAPE	NONE	EPDM SPUNGE RUB.	Non Preferred
9	UNI-GRIP	SD-202-T	TAPE	NONE	EPDM SPUNGE RUB.	Non Preferred
10	UNI-GRIP	SD-203T	TAPE	NONE	EPDM SPUNGE RUB.	Non Preferred
11	UNI-GRIP	SD-206-T	TAPE	NONE	EPDM SPUNGE RUB.	Non Preferred
12	UNI-GRIP	SD-207-T	TAPE	NONE	EPDM SPUNGE RUB.	Non Preferred
13	UNI-GRIP	SD-208-T	TAPE	NONE	EPDM SPUNGE RUB.	Non Preferred
14	UNI-GRIP	SD-209-T	TAPE	NONE	EPDM SPUNGE RUB.	Non Preferred

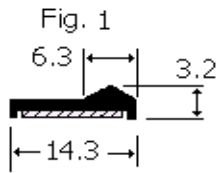

Fig. 1
DO-01-T

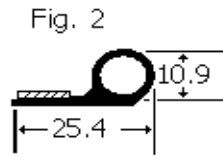

Fig. 2
SD-112-T

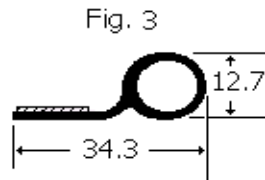

Fig. 3
SD-113-T

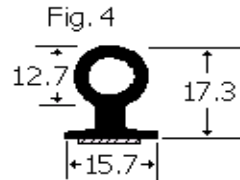

Fig. 4
SD-116-T

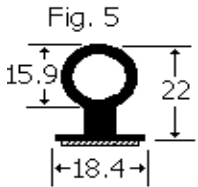

Fig. 5
SD-117-T

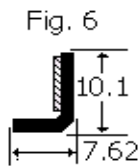

Fig. 6
PC-125-T

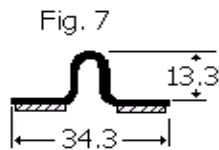

Fig. 7
GF-145-T

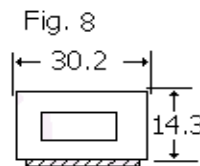

Fig. 8
SD-190-WT
WHITE

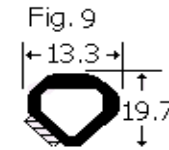

Fig. 9
SD-202T

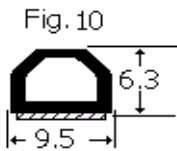

Fig. 10
SD-203-T

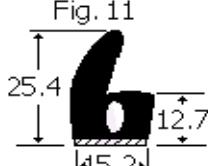

Fig. 11
SD-206-T

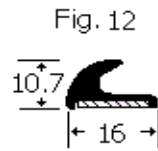

Fig. 12
SD-207-T

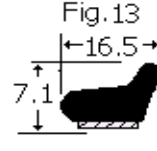

Fig. 13
SD-208-T

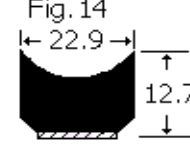

Fig. 14
SD-209-T

For new part numbers contact Deere & Co Engineering Standards: (309) 765-4918 or (309) 765-4712

JOHN DEER GUIDE 5, EDGE TRIM, WINDOW AND DOOR SEALS

TAPE SEALS

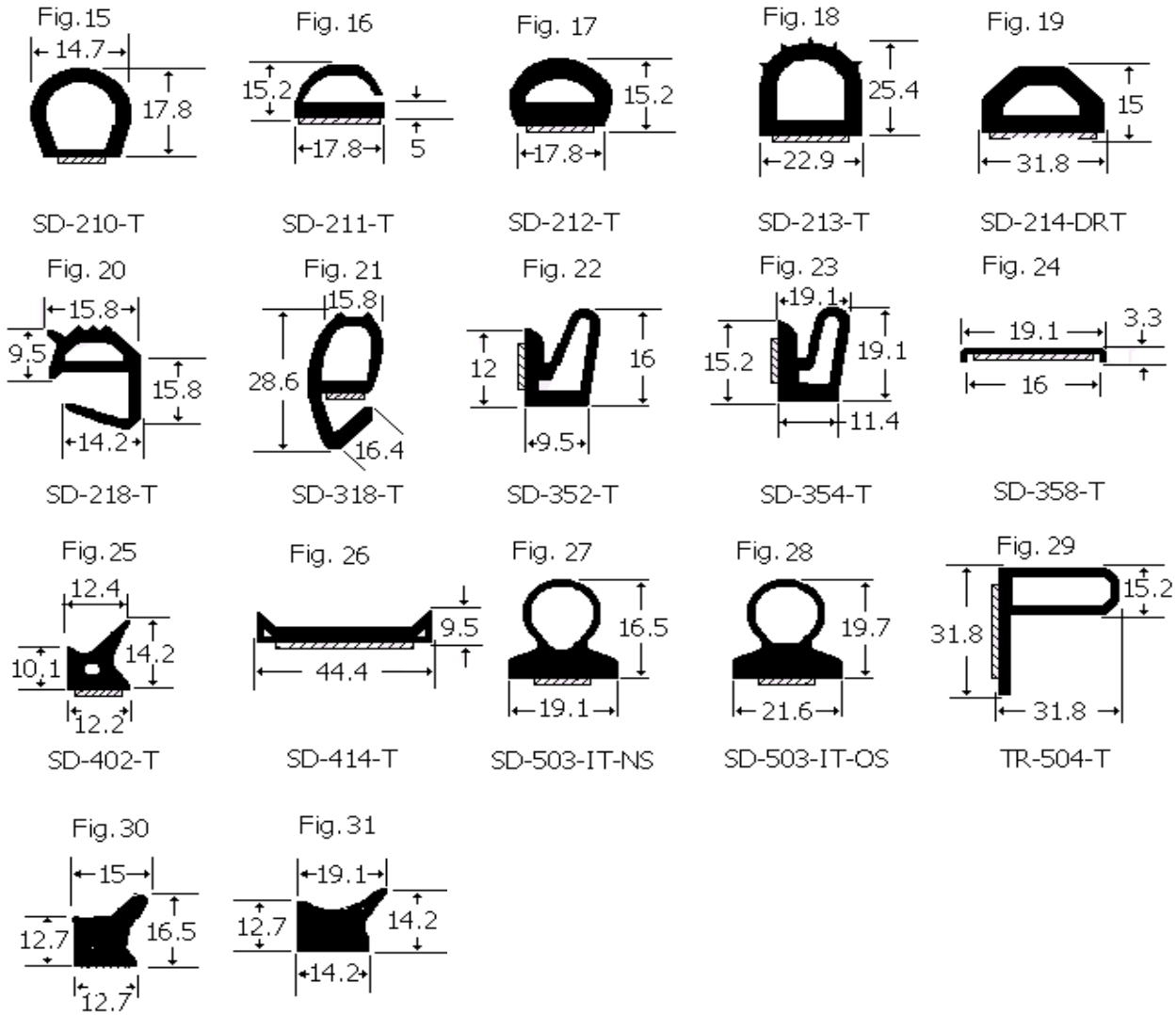

FIG.	PART NUMBER	I.D. NUMBER	GRIP/TAPE	REINFORCEMENT	MATERIAL	LENGTH	
15	UNI-GRIP	SD-210-T	TAPE	NONE	EPDM SPUNGE RUB.		Non Preferred
16	UNI-GRIP	SD-211-T	TAPE	NONE	EPDM SPUNGE RUB.		Non Preferred
17	UNI-GRIP	SD-212-T	TAPE	NONE	EPDM SPUNGE RUB.		Non Preferred
18	UNI-GRIP	SD-213-T	TAPE	NONE	EPDM SPUNGE RUB.		Non Preferred
19	UNI-GRIP	SD-214-DRT	TAPE	NONE	EPDM SPUNGE RUB.		Non Preferred
20	UNI-GRIP	SD-218-T	TAPE	NONE	EPDM SPUNGE RUB.		Non Preferred
21	UNI-GRIP	SD-318-T	TAPE	NONE	EPDM SPUNGE RUB.		Non Preferred
22	UNI-GRIP	SD-352-T	TAPE	NONE	EPDM SPUNGE RUB.		Non Preferred
23	UNI-GRIP	SD-354-T	TAPE	NONE	EPDM SPUNGE RUB.		Non Preferred
24	UNI-GRIP	SD-358-T	TAPE	NONE	EPDM SPUNGE RUB.		Non Preferred
25	UNI-GRIP	SD-402-T	TAPE	NONE	EPDM SPUNGE RUB.		Non Preferred
26	UNI-GRIP	SD-414-T	TAPE	NONE	EPDM SPUNGE RUB.		Non Preferred
27	M140860	UNI-GRIP	SD-503-IT-NS	TAPE	EPDM SPUNGE RUB.	15420	S
28	UNI-GRIP	SD-503-IT-OS	TAPE	NONE	EPDM SPUNGE RUB.		Non Preferred
29	UNI-GRIP	TR-504-T	TAPE	NONE	EPDM SPUNGE RUB.		Non Preferred
30	T50834		NO	NONE	EPDM SPUNGE RUB.		
31	701247000		NO	NONE	EPDM SPUNGE RUB.		

For new part numbers contact Deere & Co Engineering Standards: (309) 765-4918 or (309) 765-4712

JOHN DEER GUIDE 5, EDGE TRIM, WINDOW AND DOOR SEALS

ACCORDIAN SEALS

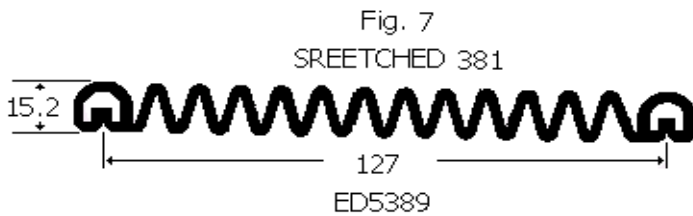
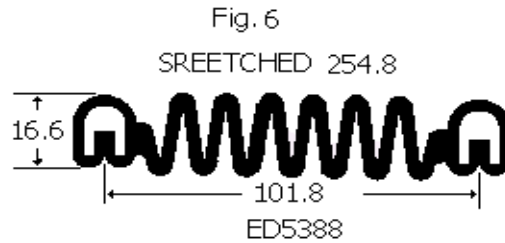
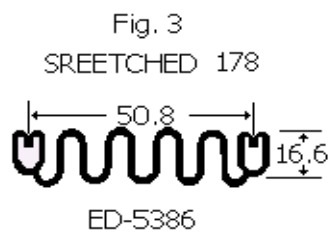
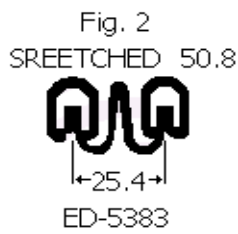
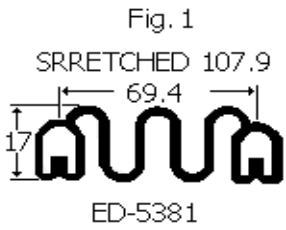

FIG.	PART NUMBER	I.D. NUMBER	GRIP/SIZE mm	REINFORCEMENT	MATERIAL	LENGTH
1	UNI-GRIP	ED-5381	3.1-4.8	FLEXABLE STEEL CORE	EPDM SPUNGE RUB.	Non Preferred
2	UNI-GRIP	ED-5383	3.1-4.8	FLEXABLE STEEL CORE	EPDM SPUNGE RUB.	Non Preferred
3	UNI-GRIP	ED-5386	3.1-4.8	FLEXABLE STEEL CORE	EPDM SPUNGE RUB.	Non Preferred
4	UNI-GRIP	ED-3282	3.1-4.8	FLEXABLE STEEL CORE	EPDM SPUNGE RUB.	Non Preferred
5	UNI-GRIP	ED-5384	3.1-4.8	FLEXABLE STEEL CORE	EPDM SPUNGE RUB.	Non Preferred
6	UNI-GRIP	ED-5388	3.1-4.8	FLEXABLE STEEL CORE	EPDM SPUNGE RUB.	Non Preferred
7	UNI-GRIP	ED-5389	3.1-4.8	FLEXABLE STEEL CORE	EPDM SPUNGE RUB.	Non Preferred

For new part numbers contact Deere & Co Engineering Standards: (309) 765-4918 or (309) 765-4712

JOHNDEERE GUIDE 5, EDGE TRIM, WINDOW AND DOOR SEALS
SPECIAL COMPOUNDS SEALS

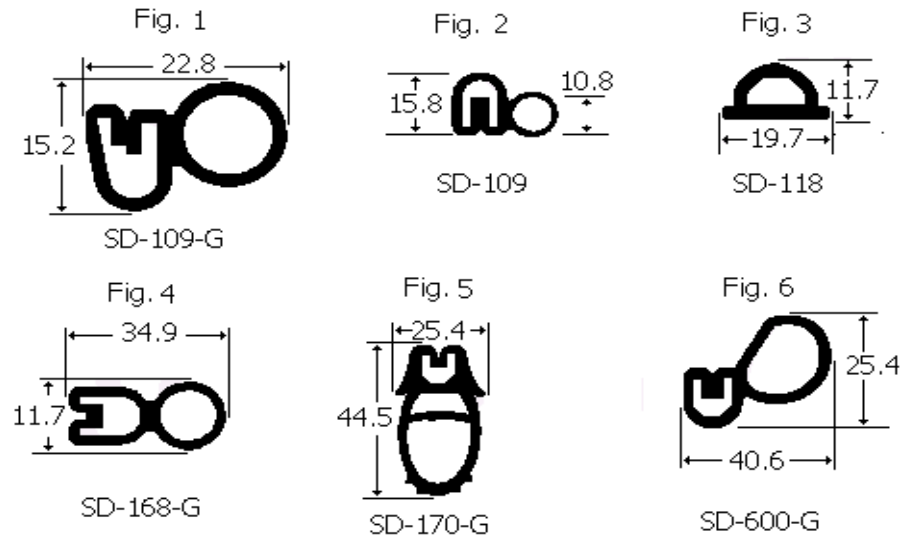

FIG.	PART NUMBER	I.D. NUMBER	GRIP/SIZE mm	REINFORCEMENT	MATERIAL	LENGTH
1	UNI-GRIP	SD-109-G	3.1-4.8	FLEXABLE STEEL CORE	SILICONE	Non Preferred
2	UNI-GRIP	SD-109	3.1-4.8	FLEXABLE STEEL CORE	NITRILE	Non Preferred
3	UNI-GRIP	SD-118	3.1-4.8	FLEXABLE STEEL CORE	NITRILEE	Non Preferred
4	UNI-GRIP	SD-168-G	3.1-4.8	FLEXABLE STEEL CORE	SILICONE	Non Preferred
5	UNI-GRIP	SD-170-G	3.1-4.8	FLEXABLE STEEL CORE	SILICONE	Non Preferred
6	UNI-GRIP	SD-600-G	3.1-4.8	FLEXABLE STEEL CORE	SILICONE	Non Preferred

For new part numbers contact Deere & Co Engineering Standards: (309) 765-4918 or (309) 765-4712

JOHNDEERE GUIDE 5, EDGE TRIM, WINDOW AND DOOR SEALS
SPECIAL COMPOUNDS SEALS

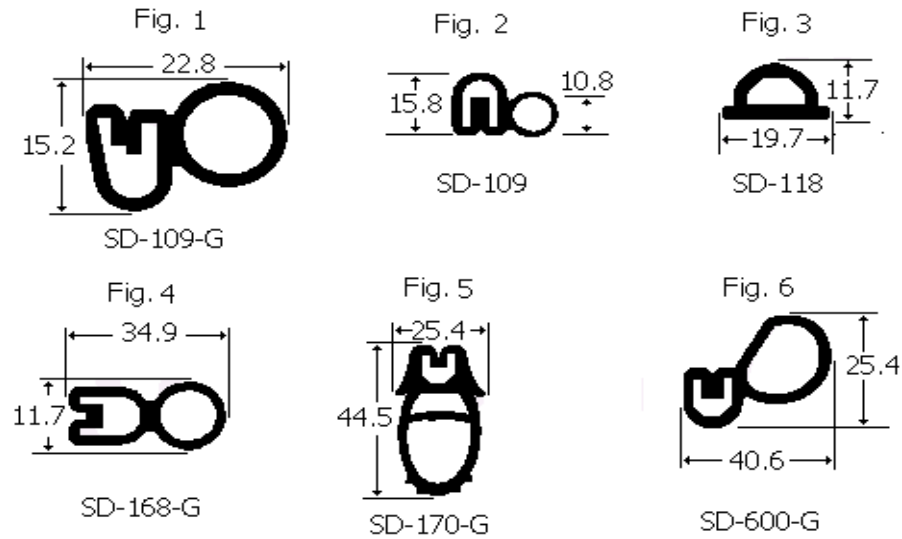

FIG.	PART NUMBER	I.D. NUMBER	GRIP/SIZE mm	REINFORCEMENT	MATERIAL	LENGTH
1	UNI-GRIP	SD-109-G	3.1-4.8	FLEXABLE STEEL CORE	SILICONE	Non Preferred
2	UNI-GRIP	SD-109	3.1-4.8	FLEXABLE STEEL CORE	NITRILE	Non Preferred
3	UNI-GRIP	SD-118	3.1-4.8	FLEXABLE STEEL CORE	NITRILEE	Non Preferred
4	UNI-GRIP	SD-168-G	3.1-4.8	FLEXABLE STEEL CORE	SILICONE	Non Preferred
5	UNI-GRIP	SD-170-G	3.1-4.8	FLEXABLE STEEL CORE	SILICONE	Non Preferred
6	UNI-GRIP	SD-600-G	3.1-4.8	FLEXABLE STEEL CORE	SILICONE	Non Preferred

For new part numbers contact Deere & Co Engineering Standards: (309) 765-4918 or (309) 765-4712

U CHANNEL EDGE GRIP TRIM

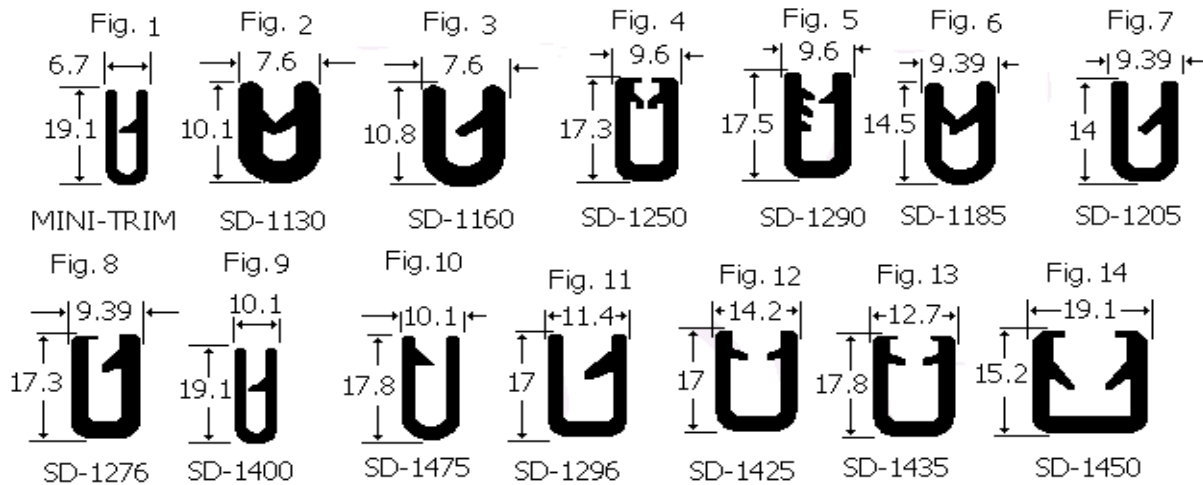

FIG.	PART NUMBER		I.D. NUMBER	GRIP/SIZE mm	REINFORCEMENT	MATERIAL	LENGTH	BULK
1	T36043	UNI-GRIP	MINI TRIM	1/32"-1/16", .8 - 1.6	FLEXABLE STEEL CORE	PVC	1422.5	
1	MT1214	UNI-GRIP	MINI TRIM	1.6	FLEXABLE STEEL CORE	PVC	158	
2	N209537	UNI-GRIP	SD-1130	1/32"-3/32", 1.6 - 2.38	FLEXABLE STEEL CORE	PVC	7620	S
2	N198208	UNI-GRIP	SD-1130	1/32"-3/32", 1.6 - 2.38	FLEXABLE STEEL CORE	PVC	7620	
2	L36206				FLEXABLE STEEL CORE	PVC	302	
3	E86508	UNI-GRIP	SD-1130	1/32"-3/32", 1.6 - 2.38	FLEXABLE STEEL CORE	PVC	325	
3	N209532	UNI-GRIP	SD-1160	1/32"-3/32", 1.6 - 2.38	FLEXABLE STEEL CORE	PVC	530.3	
3	N209537	UNI-GRIP	SD-1160	1/32"-3/32", 1.6 - 2.38	FLEXABLE STEEL CORE	PVC	7620	S
3	N209637			1/32"-3/32", 1.6 - 2.38	FLEXABLE STEEL CORE	PVC	304.8	
3	M140653			1/32"-3/32", 1.6 - 2.38	FLEXABLE STEEL CORE	PVC		
3	T45414			1/32"-3/32", 1.6 - 2.38	FLEXABLE STEEL CORE	PVC	407.9	
3	T61798			1/32"-3/32", 1.6 - 2.38	FLEXABLE STEEL CORE	PVC	15240	S
3	DT5062			1/32"-3/32", 1.6 - 2.38	FLEXABLE STEEL CORE	PVC	NONE	
3	M140614			1/32"-3/32", 1.6 - 2.38	FLEXABLE STEEL CORE	PVC	35	
4		UNI-GRIP	SD-1250	3/32"-5/32", 2.3 - 3.9	FLEXABLE STEEL CORE	PVC		Non Preferred
5		UNI-GRIP	SD-1290	3/32"-5/32", 2.3 - 3.9	FLEXABLE STEEL CORE	PVC		Non Preferred
6	N155090	UNI-GRIP	SD-1185	1/32"-3/32", 1.6 - 2.38	FLEXABLE STEEL CORE	PVC	1003	
6	N190884	UNI-GRIP	SD-1185	1/32"-3/32", 1.6 - 2.38	FLEXABLE STEEL CORE	PVC	152.4	
6	N192419	UNI-GRIP	SD-1185	1/32"-3/32", 1.6 - 2.38	FLEXABLE STEEL CORE	PVC	251	
6	N194092	UNI-GRIP	SD-1185	1/32"-3/32", 1.6 - 2.38	FLEXABLE STEEL CORE	PVC	375.1	
6	N279864	UNI-GRIP	SD-1185	1/32"-3/32", 1.6 - 2.38	FLEXABLE STEEL CORE	PVC	285.7	
6	RE54810				FLEXABLE STEEL CORE	PVC	69	
6	RE56284						45	
6	N155090			3	FLEXABLE STEEL CORE	PVC	1003	
6	811611500	SPA-E-NAUR	825-002	1/32"-1/8", 1.6-3.1	FLEXABLE STEEL CORE	PVC	30480	S
7	A46232			1.5-4.3	FLEXABLE STEEL CORE	PVC	264	
7	E70161	UNI-GRIP	SD-1205	1/16"-1/8", 1.6 - 3.1	FLEXABLE STEEL CORE	PVC	190	
7	E75517	UNI-GRIP	SD-1205	1/16"-1/8", 1.6 - 3.1	FLEXABLE STEEL CORE	PVC	100	
7	E81752	UNI-GRIP	SD-1205	1/16"-1/8", 1.6 - 3.1	FLEXABLE STEEL CORE	PVC	75	
7	L62810	UNI-GRIP	SD-1205	1/16"-1/8", 1.6 - 3.1	FLEXABLE STEEL CORE	PVC		
7	T58056			1.5-4.3	FLEXABLE STEEL CORE	PVC	7620	S
7	T110174				FLEXABLE STEEL CORE	PVC		
8		UNI-GRIP	SD-1276	1/16"-1/8", 1.6 - 3.1	FLEXABLE STEEL CORE	PVC		Non Preferred
9		UNI-GRIP	SD-1400	3/32"-5/32", 2.3 - 3.9	FLEXABLE STEEL CORE	PVC		Non Preferred
10		UNI-GRIP	SD-1475	3/32"-5/32", 2.3 - 3.9	FLEXABLE STEEL CORE	PVC		Non Preferred
10	E70161				FLEXABLE STEEL CORE	PVC	190	
10	E75517				FLEXABLE STEEL CORE	PVC	100	
11	E81752				FLEXABLE STEEL CORE	PVC	75	

For new part numbers contact Deere & Co Engineering Standards: (309) 765-4918 or (309) 765-4712

U CHANNEL EDGE GRIP TRIM

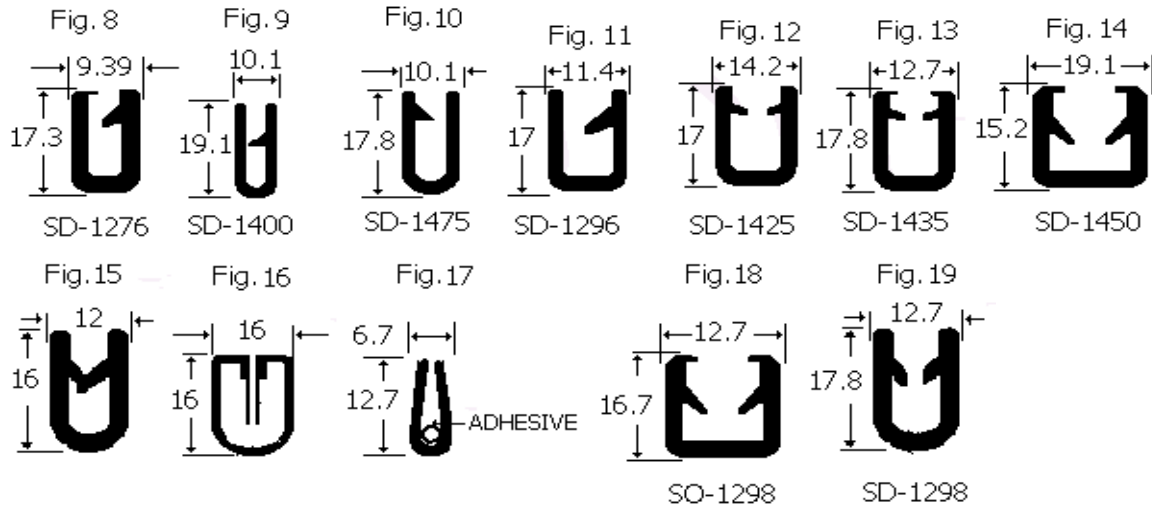

FIG PART NUMBER	I.D. NUMBER	GRIP/SIZE mm	REINFORCEMENT MATERIAL	LENGTH	BULK
11 L62811	SD-1296	5/32"-7/32", 4 - 5.5	FLEXIBLE STEEL CORE	PVC	
11 M90176	SD-1296	5.5	FLEXIBLE STEEL CORE	PVC	
11 M72912	SD-1296	5.5	FLEXIBLE STEEL CORE	PVC	3048
11 N193323	SD-1296	5.5	FLEXIBLE STEEL CORE	PVC	82.5
11 R41353	SD-1296	4.8	FLEXIBLE STEEL CORE	PVC	1453
11 R54792	SD-1296	4.8	FLEXIBLE STEEL CORE	PVC	152
11	SD-1296	5.5	FLEXIBLE STEEL CORE	PVC	Non Preferred
12 AH161882	SD-1425	1/4"-5/16", 6.3 - 8	FLEXIBLE STEEL CORE	PVC	610
11 L39233		6.5	FLEXIBLE STEEL CORE	PVC	
13 E90419	SD-1435	1/4"-5/16", 6.3 - 8	FLEXIBLE STEEL CORE	PVC	432
13 N242318	SD-1435	1/4"-5/16", 6.3 - 8	FLEXIBLE STEEL CORE	PVC	139.7
13 W42423	SD-1435	1/4"-5/16", 6.3 - 8	FLEXIBLE STEEL CORE	PVC	500
14 A40247	SD-1450	7/16"-1/2", 11.1 - 12.7	FLEXIBLE STEEL CORE	PVC	
14 E61375	SD-1450	7/16"-1/2", 11.1 - 12.7	FLEXIBLE STEEL CORE	PVC	292.1
14 E62084	SD-1450	7/16"-1/2", 11.1 - 12.7	FLEXIBLE STEEL CORE	PVC	76.3
14 E75520	SD-1450	7/16"-1/2", 11.1 - 12.7	FLEXIBLE STEEL CORE	PVC	203
15 AT200530		8	FLEXIBLE STEEL CORE	PVC	150
16 AH133704			FLEXIBLE STEEL CORE	PVC	
16 AH163306			FLEXIBLE STEEL CORE	PVC	413
16 AH162921			FLEXIBLE STEEL CORE	PVC	913
17 ET16663		1.52	FLEXIBLE STEEL CORE	PVC	2475
17 R88613		1.52	FLEXIBLE STEEL CORE	PVC	1526 S
18 N240083		1/8"-1/4", 3.4 - 6.35	FLEXIBLE STEEL CORE	PVC	139.7
19 N242318		1/4"-5/16", 6.3 - 8	FLEXIBLE STEEL CORE	PVC	139.7

For new part numbers contact Deere & Co Engineering Standards: (309) 765-4918 or (309) 765-4712

JOHN DEERE GUIDE 5, EDGE TRIM, WINDOW AND DOOR SEALS

INDEX								
PART NUMBER	PAGE	FIG.	PART NUMBER	PAGE	FIG.	PART NUMBER	PAGE	FIG.
701247000	10	31	E86325	3	28	N240083	15	18
811611500	14	6	E86508	14	3	N242318	15	13
A40247	15	14	E90419	15	13	N279864	14	6
A46232	14	7	ET16663	15	17	R28122	5	4
AE41176	3	28	H100459	13	1	R33846	5	4
AH125163	4	36	H100460	13	3	R41353	15	11
AH130137	3	28	H107566	5	7	R54792	15	11
AH133704	15	16	H112762	5	11	R58348	13	2
AH133705	3	17	H131108	3	17	R88613	15	17
AH139393	7	25	H151068	4	34	RE54810	14	6
AH140967	3	17	H167220	4	34	RE56284	14	6
AH141774	7	26	H92018	5	6	T110174	14	7
AH160269	7	21	L36206	14	2	T132817	3	28
AH160298	3	16	L39233	15	11	T30857	13	6
AH160405	9	4	L62810	14	7	T36043	14	1
AH161882	15	12	L62811	15	11	T36043	5	19
AH162921	15	16	M140614	14	3	T41341	7	21
AH163306	15	16	M140653	14	3	T41342	7	21
AH168669	3	16	M140855	2	11	T45414	14	3
AH168675	3	16	M140860	10	27	T50834	10	30
AH170252	3	16	M43640	5	5	T52386	13	7
AH80335	3	28	M43979	5	5	T55178	5	8
AH83276	2	2	M44292	5	5	T58044	5	10
AH83825	3	28	M44391	5	5	T58056	14	7
AM129203	3	17	M72912	15	11	T58339	13	5
AR67041	3	17	M90176	15	11	T58340	13	4
AT200530	15	15	MT1214	14	1	T58341	2	2
DT5004	3	17	N113194	13	1	T61798	14	3
DT5062	14	3	N155090	14	6	T62560	13	3
DT5133	7	5	N155090	14	6	T62710	5	5
E54965	5	9	N190884	14	6	T63949	3	17
E61375	15	14	N192419	14	6	T66354	5	3
E62084	15	14	N193323	15	11	T71383	13	1
E70161	14	7	N194092	14	6	UN5503	4	31
E75517	14	7	N198208	14	2	W42423	15	13
E75520	15	14	N209532	14	3			
E80976	3	17	N209537	14	2			
E81651	3	28	N209537	14	3			
E81752	14	7	N221372	3	16			

For new part numbers contact Deere & Co Engineering Standards: (309) 765-4918 or (309) 765-4712